

Diritti riservati

All rights reserved

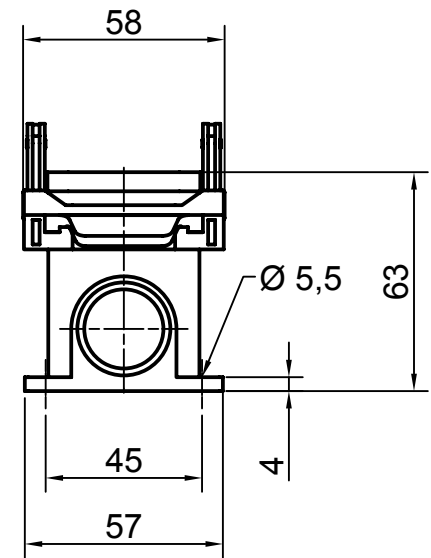
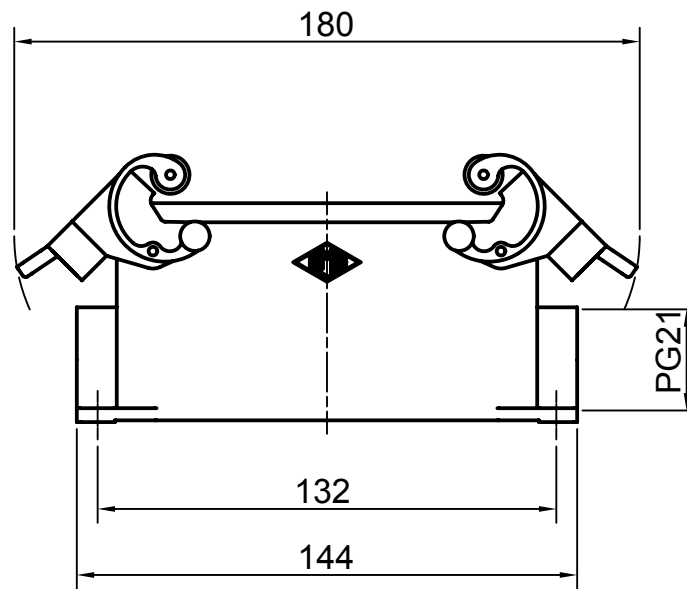

Date 04.01.2007	CMP 16		Scale
Sign.	surface mounting h. 2 lev. PG21 ins.		1:2
			